

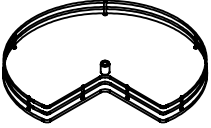



**Component list**

<p>A 2 pcs</p> 	<p>B 1 pc</p> 	<p>C 2 pcs</p> 
<p>D 1 pc</p> 	<p>E 1 pc</p> 	<p>F 2 pcs</p> 
<p>G 2 pcs</p> 	<p>H 8 pcs</p>  <p>ST4*14</p>	

**Dimensions (mm)**

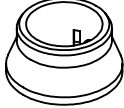
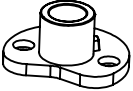
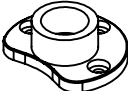
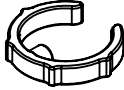
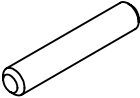
Cabinet size	Depth (D)	Width (W)	Height (H)	Front edge distance (X)
900	≥500	900	750≥H≥600	120

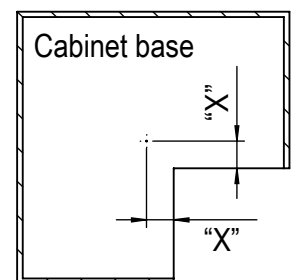
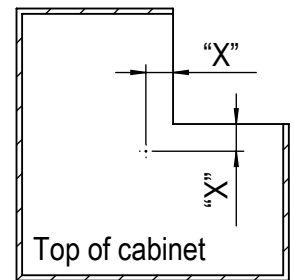
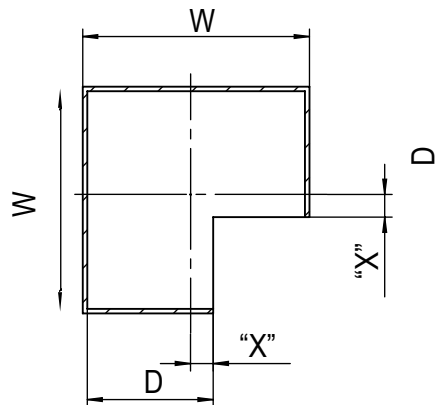
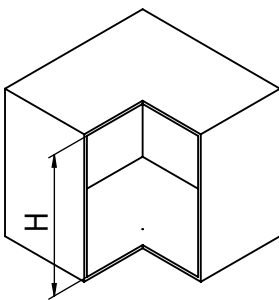

# Installation

- 1) Mark out two parallel lines with distance X from front edge of cabinet
- 2) Fit parts D and E with H at the intersection of the two lines

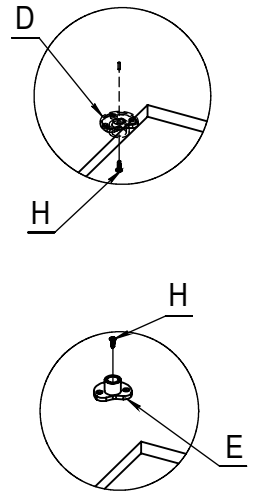
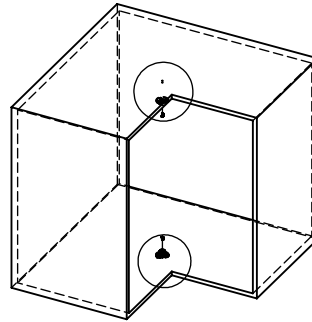

- 3) Assemble parts A, B, C, F, G to complete carousel

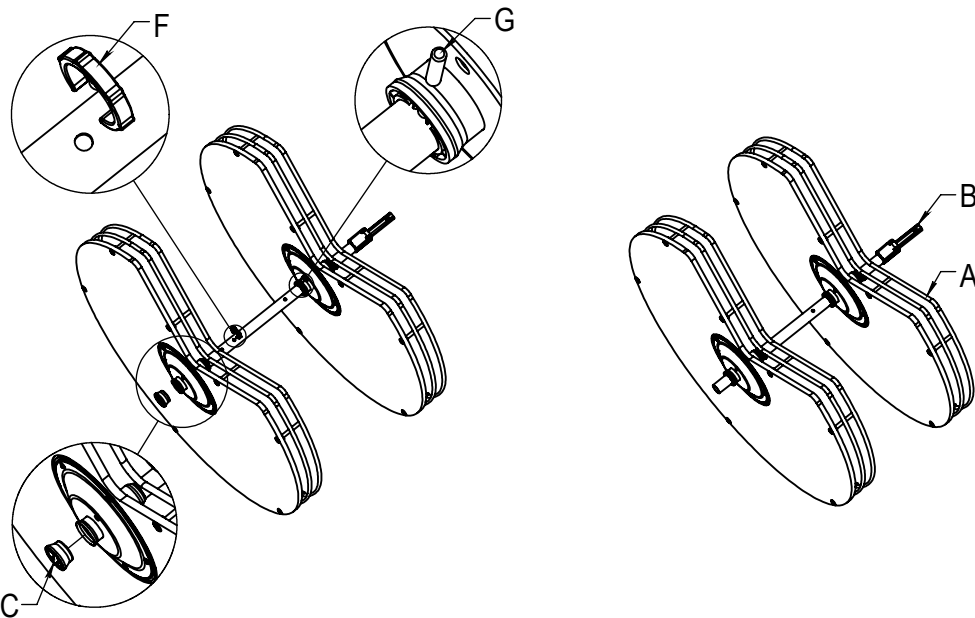

- 4) Lock assembly into D and E to complete installation

